

## TABLE OF CONTENT

<b>Nr./ No</b>	<b>Artikulli/ Article</b>	<b>Njesia/ Unit</b>	<b>Sasia/ Quantity</b>
1	Tavoline pune/ Desk	cope/piece	<b>2</b>
2	Bllok sirtaresh/ Drawer	cope/piece	<b>2</b>
3	Krevat vizite/ Examination Bed	cope/piece	<b>4</b>
4	Kartoteke gjysem e mbyllur/ Shelf	cope/piece	<b>7</b>
5	Mobilje ilacesh/ Shelf for Medicine	cope/piece	<b>2</b>
6	Dollap veshjesh personeli/ Personel shelf	cope/piece	<b>1</b>
7	Karrige statike/ Static chair	cope/piece	<b>13</b>
8	Karrige mjeku diagnostikimi/ Stool	cope/piece	<b>2</b>
9	Stativ serumi/ Serum holder	cope/piece	<b>2</b>
10	Tavoline mbledhjesh/ Meeting room table	cope/piece	<b>1</b>
11	Grila perde/ Curtain	m2	<b>15</b>
12	Shkalle krevati/ Portable stairs	cope/piece	<b>4</b>
13	Mobilje receptioni 'A'/ Reception desk A	cope/piece	<b>1</b>
14	Raft metalik/ Metallic shelf	cope/piece	<b>1</b>
15	Stola pritjeje 3 poste / Waiting benches 3 posts	cope/piece	<b>1</b>

# ARTIKULL 1: Tavoline pune

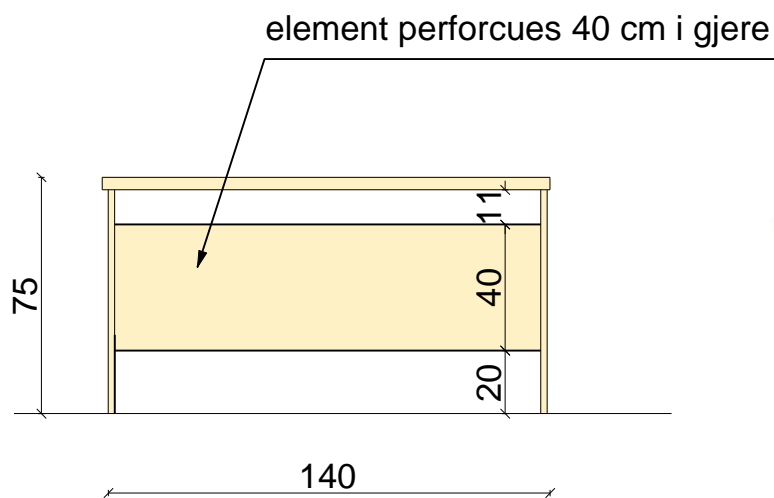
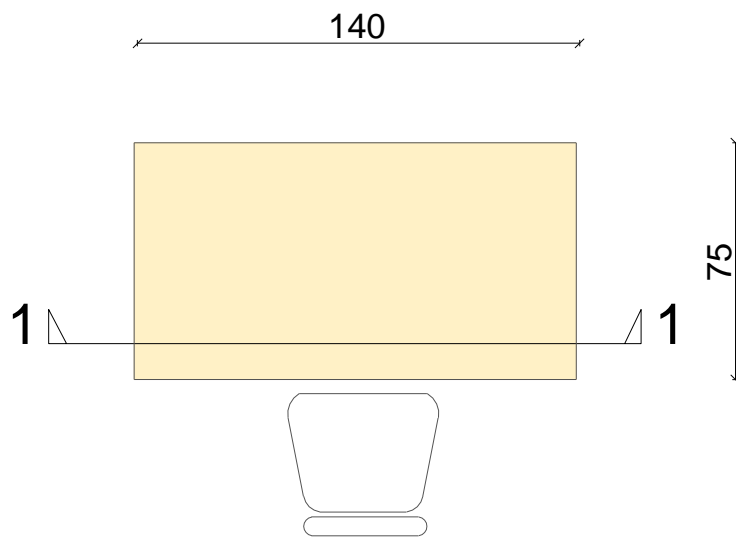

\*\*Fotoja eshte ilustruese

## Shenim:

- Materiali i perdorur eshte MDF e melaminuar
- Elementet vertikale jane 18mm
- Plani i punes eshte 32mm
- Njesite bashkohen me njera-tjetren me vida dhe filetohen me bulona
- Cepat e planit te tavolines do te jene te rakorduar
- Ngjyra te percaktohet ne fazen e dyte

## ARTIKULL 2: Bllok Sirtaresh

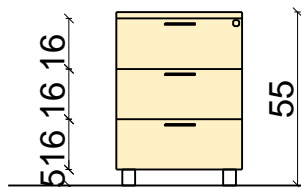
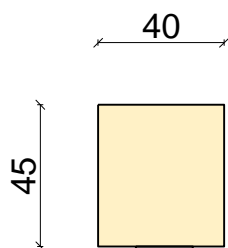

\*\*Fotoja eshte ilustruese

### Shenim:

- Materiali i perdorur eshte melamine
- Elementet vertikale jane 16mm
- Elementet horizontale jane 16mm
- Njesite bashkohen me njera-tjetren me vida dhe filetohen me bulona
- Sirtaret te kene sistem mbyllje qendrore me celes
- Blloku i sirtareve te pajiset me kater rrota
- Ngjyra te percaktohet ne fazen e dyte

## ARTIKULL 3: Krevat Pacienti

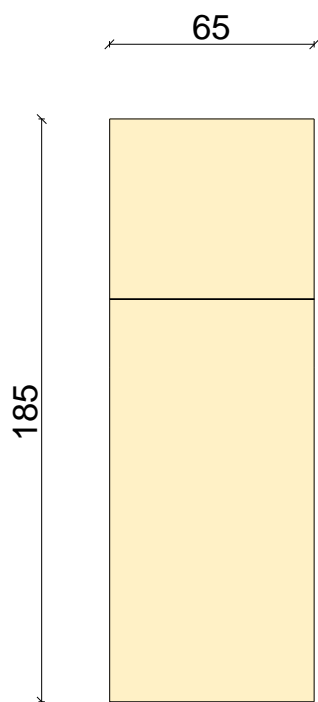

\*\*Fotoja eshte ilustruese

### Shenim:

- Dimensionet e krevatit 650x1850mm.
- Krevati te jete i rregullueshem ne disa pozicione
- Mbeshtetes e shpinores ne sigurojne komfort dhe qendrueshmeri gjate ekzaminimit
- Struktura e krevatit te jete metalike
- Dysheku te jete i inkorporuar, me shtrese te bute sfungjeri
- Materiali veshes i dyshekut te jete antibakterial dhe rezistent ndaj ujit dhe rezistent ndaj zjarrit

## ARTIKULL 4: Kartoteke gjysem e mbyllur

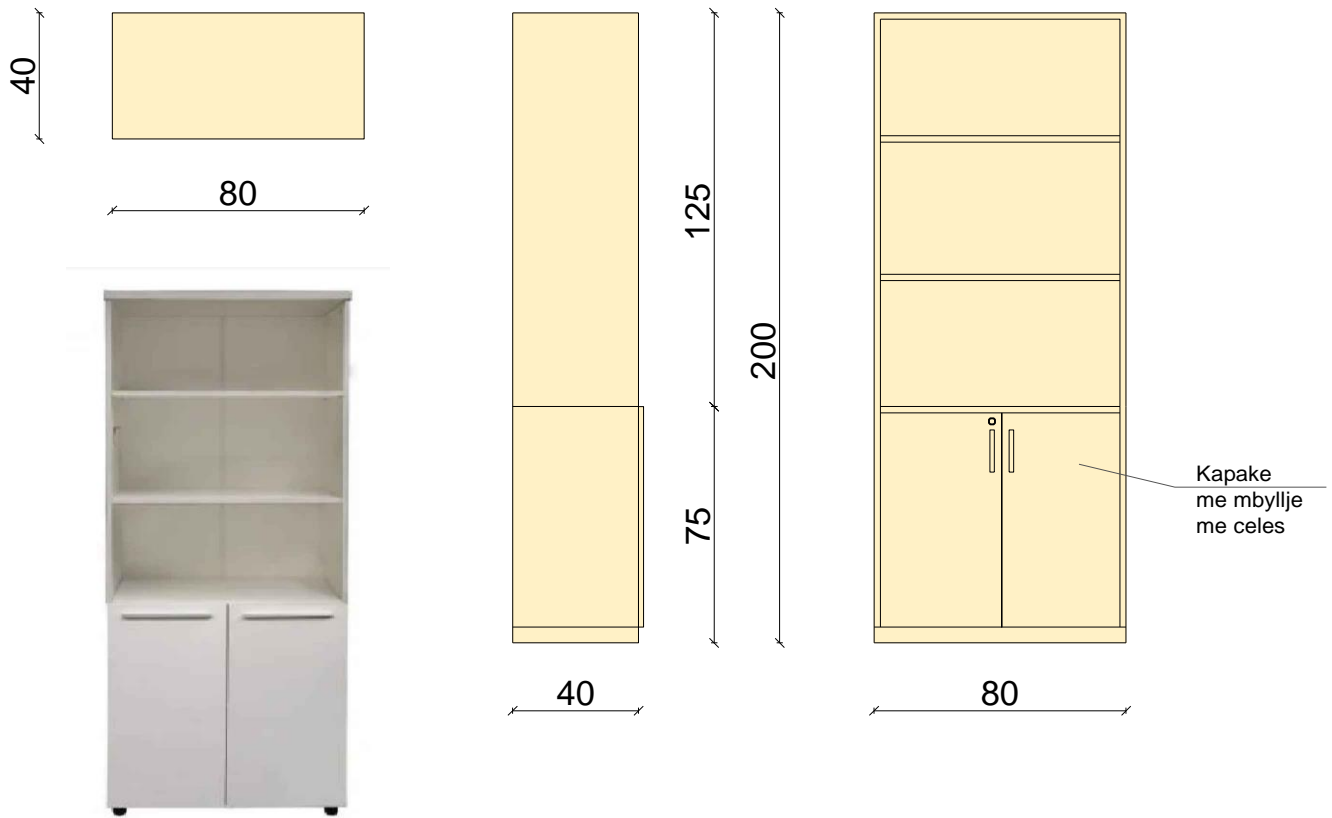

\*\*Fotoja eshte ilustruese

### Shenim:

- Dimensionet 400x800mm
- Materiali i perdorur eshte MDF i melaminuar
- Elementet vertikale dhe horizontale jane 16mm
- Mobilja do te fiksohet me prixhionere ne mur
- Kapaket do te trajtohen me bordime te plastifikuara
- Kapaket do te kene mbyllje me celes
- Ngjyra te percaktohet ne fazen e dyte

## ARTIKULL 5: Mobilje ilacesh

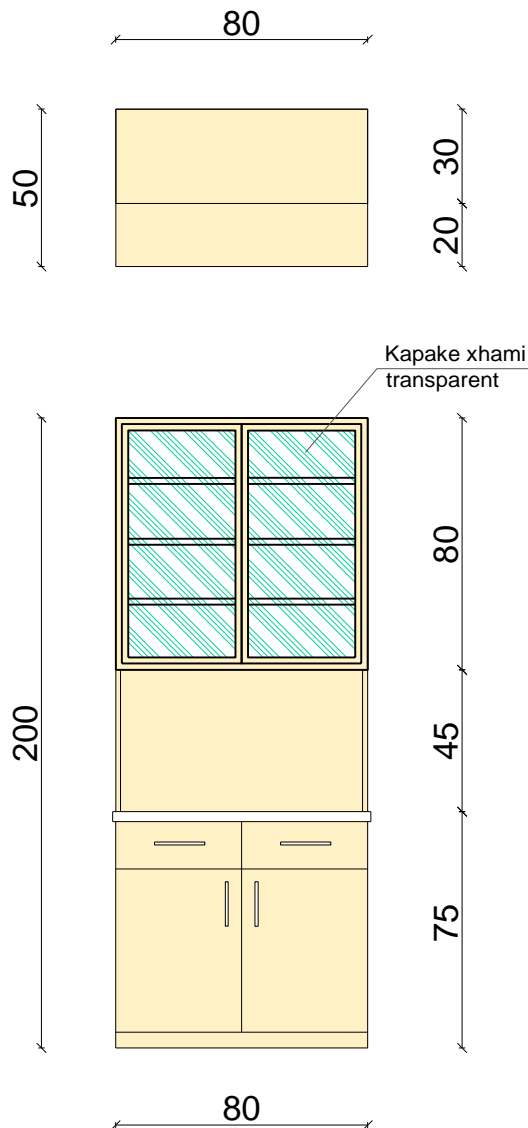

\*\*Fotoja eshte ilustruese

### Shenim:

- Materiali i perdorur eshte melamine
- Elementet vertikale dhe horizontale jane 16mm
- Plani i punes eshte 32mm
- Mobilja e sipërme do te fiksohet me prixhionere ne mur
- Kapaket do te trajtohen me bordime te plastifikuara
- Bangoja do te jete e plastifikuar-ngjyre gri metalizato
- Kapaket e raftit te sipërme do te jene me xham
- Ngjyra te percaktohet ne fazen e dyte

## ARTIKULL 6: Dollap per veshjet e personelit

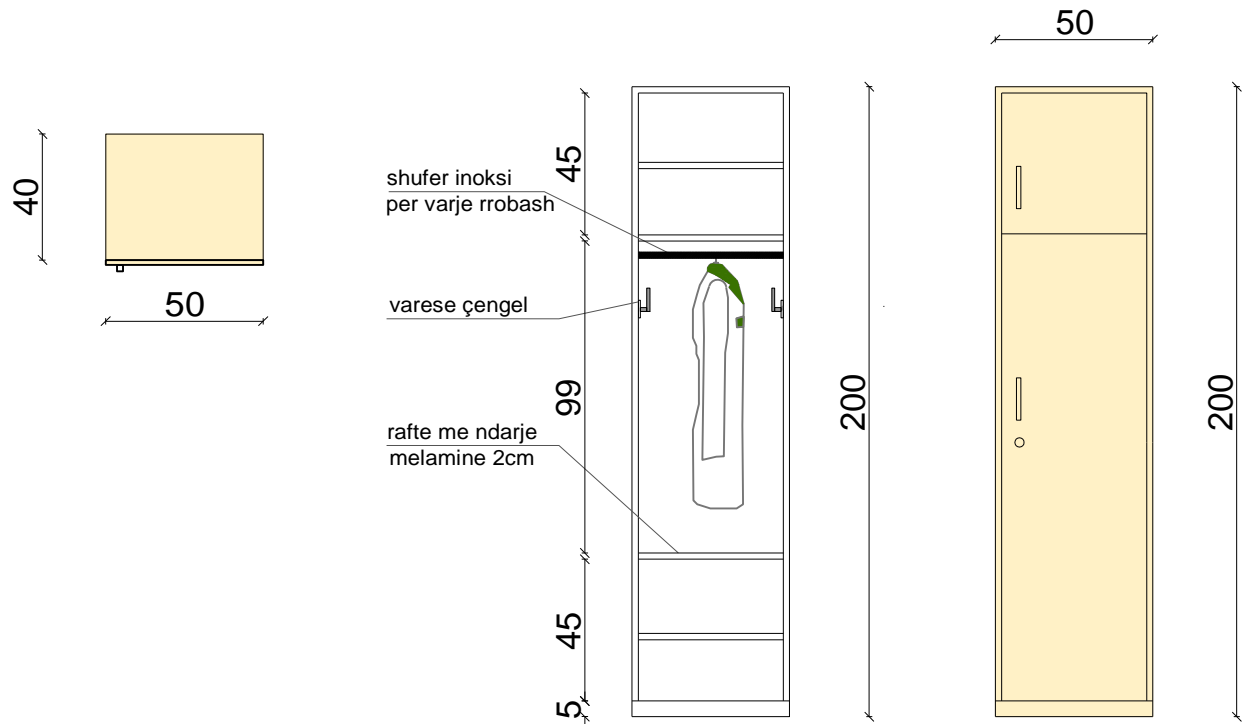

### Shenim:

- Materiali i perdorur eshte melamine
- Elementet vertikale dhe horizontale jane 16mm
- Njesite bashkohen me njera-tjetren me vida dhe filetohen me bulona
- Kapaku eshte me mbyllje qendore me çeles
- Ngjyra te percaktohet ne fazen e dyte

## ARTIKULL 7: Karrige statike

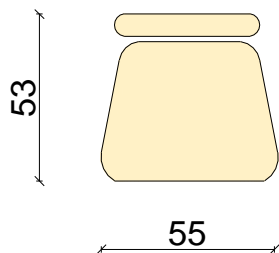

\*\*Fotoja eshte ilustruese

### Shenim:

- Dimensionet e karriges 550mmX540mmX830mm
- Materiali i ulëses dhe mbështetëses rekomandohet lekure rezistente ndaj lëvizjeve dhe fërkimeve.
- Ulesja e mbushur me sfungjer me tapiceri antibakterial
- Ngjyra te jete e zeze.
- Struktura metalike



## ARTIKULL 8: Karrige mjeku diagnostikimi

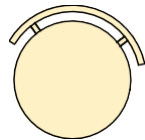

\*\*Fotoja eshte ilustruese

### Shenim:

- Kembeza unazore e kromuar
- 5 rrota metalike te zevendesueshme
- Ulesja te jete e bute qe te krijojte rehati ne levizje
- Materiali veshes - lekure antibakteriale
- Lartesia e rregullueshme 58-71cm
- Ngjyra e uleses: gri
- Ngjyra e struktures: e zeze

## ARTIKULL 9: Stativ Serumi

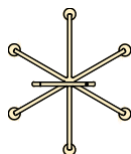

\*\*Fotoja eshte ilustruese

### Shenim:

- Materiali inoks
- 5 rrota me sistem frenimi

## ARTIKULL 10: Tavoline mbledhje

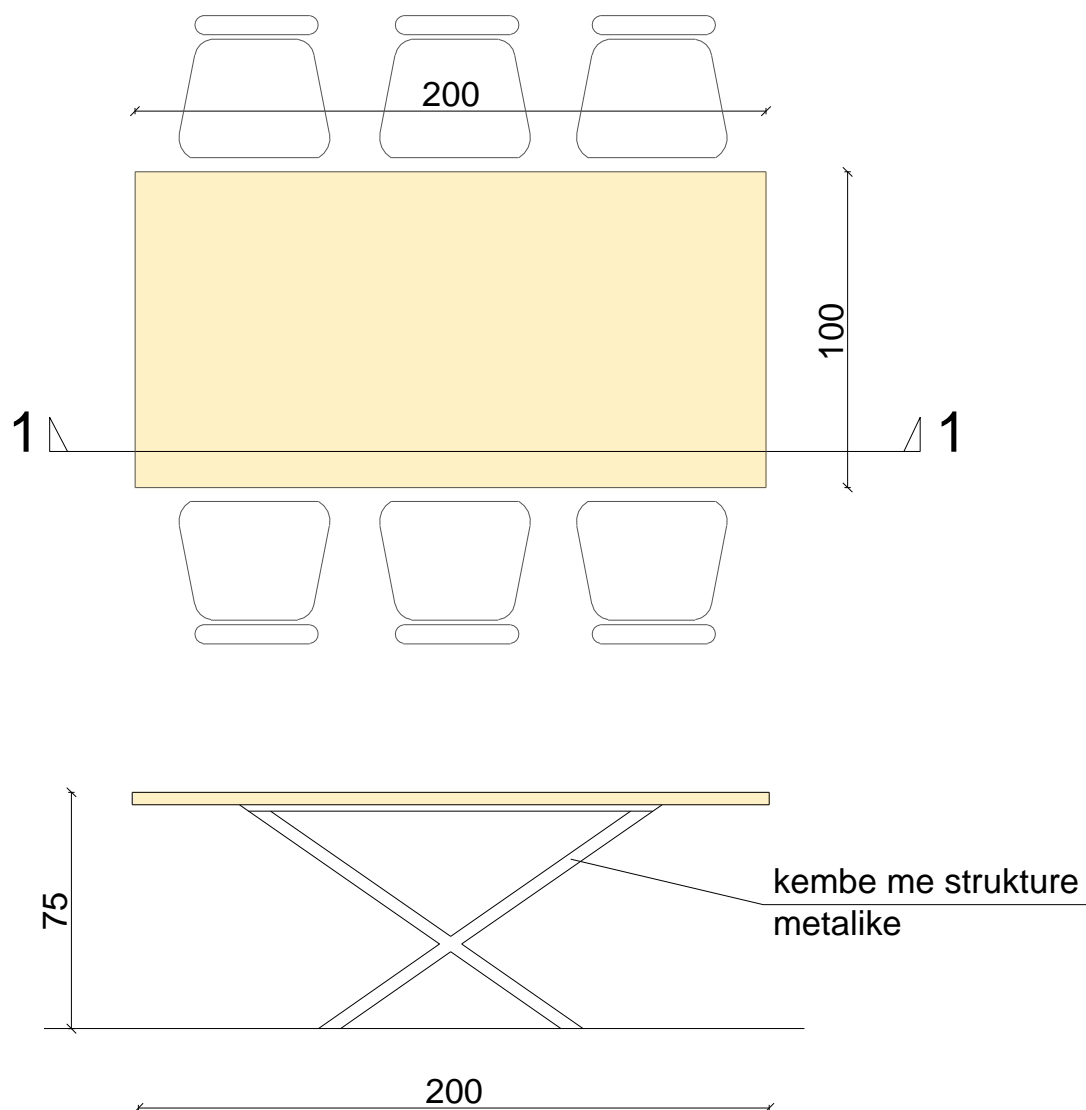

### Shenim:

- Materiali i perdorur eshte MDF e melaminuar
- Strukture metalike
- Plani i punes eshte 32mm
- Njesite bashkohen me njera-tjetren me vida dhe filetohen me bulona
- Cepat e planit te tavolines do te jene te rakorduar
- Ngjyra te percaktohet ne fazen e dyte

# ARTIKULL 11: Grila Roler

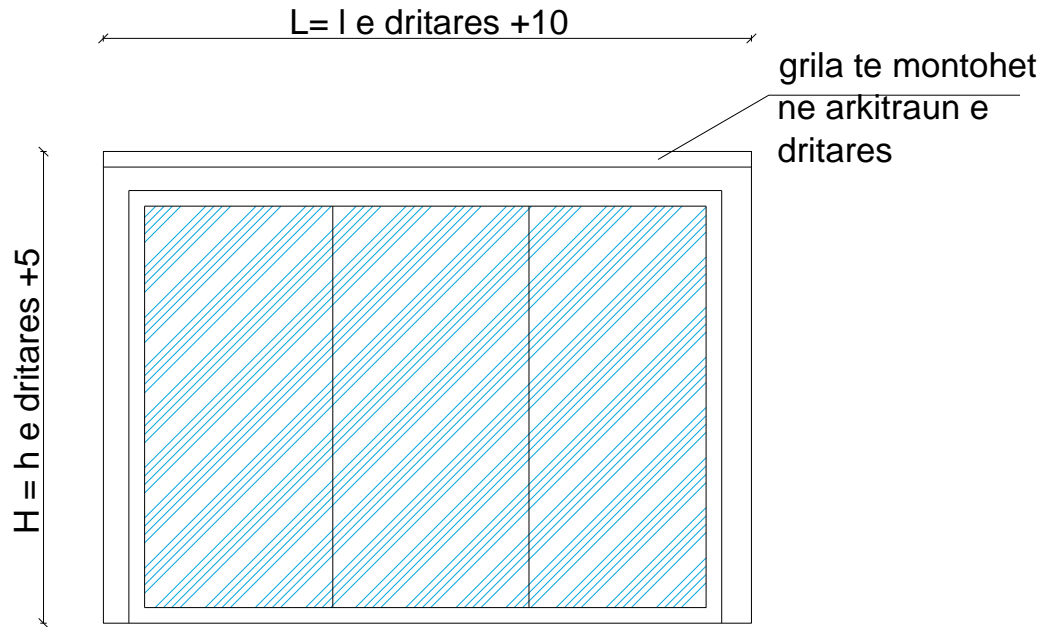

\*\*Fotoja eshte ilustruese

## Shenim:

- Materiali i rollerit dhe ngjyra te percaktohen ne faze te dyte

## ARTIKULL 12: Shkalle krevati

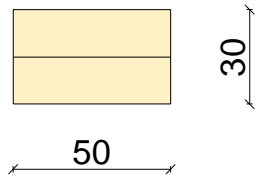

\*\*Fotoja eshte ilustruese

### Shenim:

- Shkalle ndihmese per tu ngjitur ne krevat
- Shkalle me dy shkelje te gomuara antirreshtqitje
- Struktura metalike e lyer me boje anti mikrob.
- Dimensionet: (H) 18cm x (W) 50 x (D) 30
- Maximum i peshes; 225kg

## ARTIKULL 13: Mobilje recepsioni

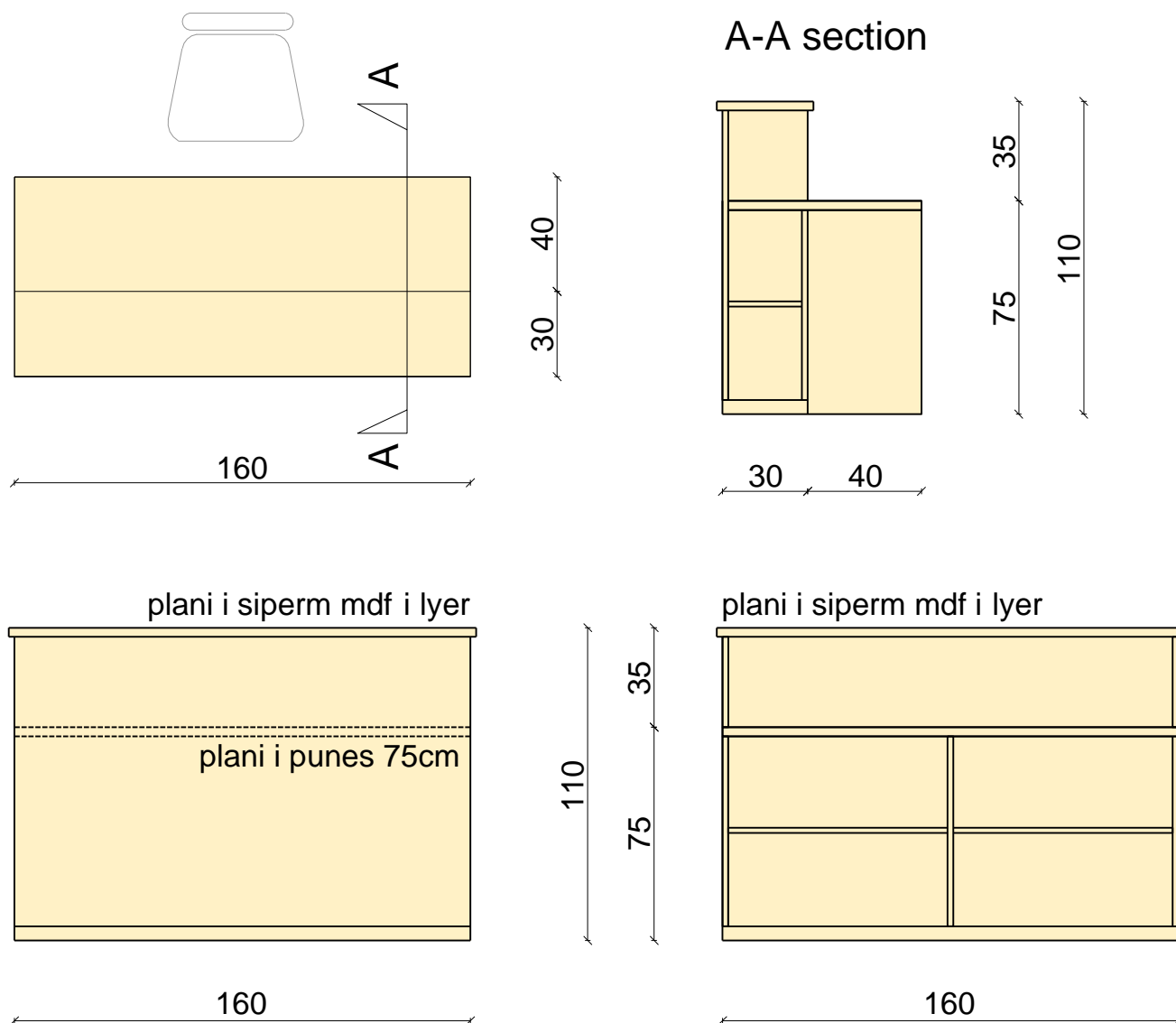

### Shenim:

- Materiali i Perdorur eshte Melamine
- Plani i siperm eshte MDF i lyer
- Plani i banakut dhe plani i punes jane 32mm.
- Elementet vertikale jane 15mm
- Elementet horizontale jane 25mm
- Njesite bashkohen me njera-tjetren me vida dhe filetohen me bulona
- Ngjyra te percaktohet ne fazen e dyte

## ARTIKULL 14: Raft Metalik

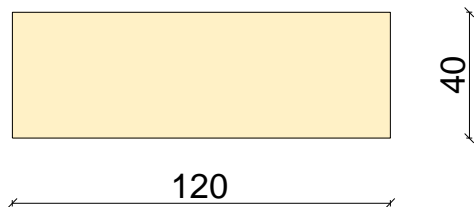

\*\*Fotoja eshte ilustruese

### Shenim:

- Struktura metalike me bulona.
- Raft i ndare ne 4 nivele.
- Dimensionet: (W) 120 x (D) 40 x (H) 200 cm
- Maximum i peshes: 200kg

## ARTIKULL 15: Stola pritje

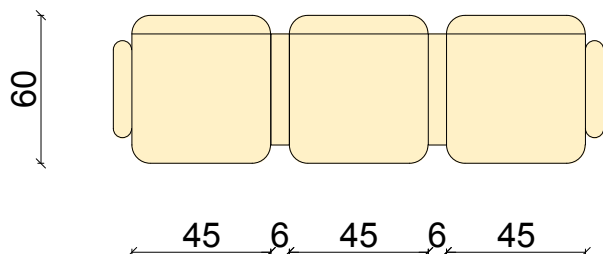

\*\*Fotoja eshte ilustruese

### Shenim:

- Stol tresh me dimension te njerit element 450x600mm
- Materiali skeletit eshte inoks
- Material i uleses eshte e tapicuar ose siperfaqe metalike.
- Stolat te fiksohen me bulona ne dysHEME